

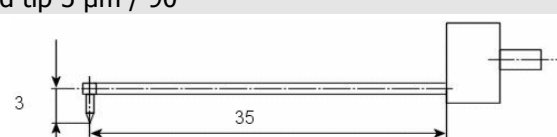

Pickup for roughness tester

Pickup for roughness tester Mahr

Order-no.	specification	Price in €
200.400-290	Tracing arm for bore greater than \varnothing 4,5 mm, for MFW-250 Diamond tip 2 μ m / 90° (compatible with 6851804)	233,00
200.400-260	Diamond tip 2 μ m / 60° (compatible with 6851828)	263,00
200.400-590	Diamond tip 5 μ m / 90°	288,00
		
200.401-290	Cranked arm 10 mm; for MFW-250 Diamond tip 2 μ m / 90° (compatible with 6851805)	237,00
200.401-260	Diamond tip 2 μ m / 60°	267,00
200.401-590	Diamond tip 5 μ m / 90°	292,00
		
200.402-290	Double length arm for for bore greater than \varnothing 4,5 mm for MFW-250 Diamond tip 2 μ m / 90° (compatible with 6851806)	247,00
200.402-260	Diamond tip 2 μ m / 60°	277,00
200.402-590	Diamond tip 5 μ m / 90°	302,00
		
200.410-290	Pickup for for bore greater than \varnothing 0,8 mm; for MFW-250 Diamond tip 2 μ m / 90° (compatible with 6851808)	340,00
200.410-260	Diamond tip 2 μ m / 60°	370,00
200.410-590	Diamond tip 5 μ m / 90°	395,00
200.410-560	Diamond tip 5 μ m / 60°	395,00
		
200.411-1500	Pickup with ball R 1,5 mm; for MFW-250 bille \varnothing 3,0 mm (compatible with 6851809)	284,00
		

Dimensions in mm; all pictures diagrammatical

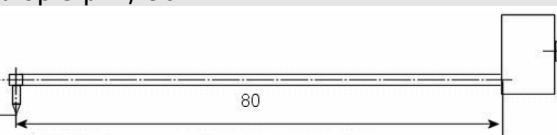
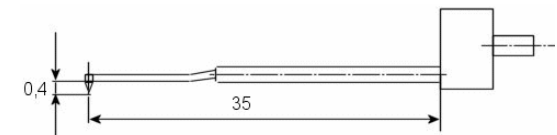
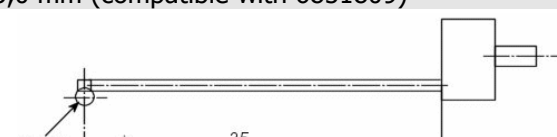
- According to your wishes we produce special pickup tracing arms, as well as tracing arms of other makers
- Prices for other quantities on request

Pickup Mahr MFW250

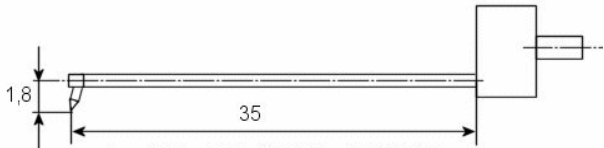
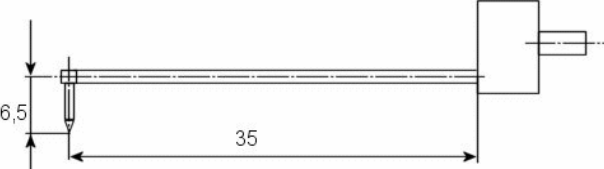
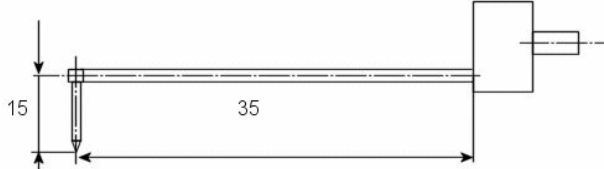
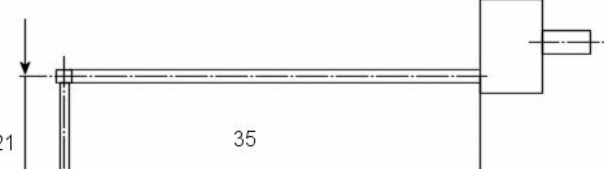
Order-no..	specification	Price in €
200.412-260 200.412-560	Pickup with inclined tip for for bore greater than \varnothing 4,0 mm; for MFW-250 Diamond tip 2 μ m / 60° (kompatibel zu 6851810) Diamond tip 5 μ m / 60°	284,00 314,00
		
200.405-290 200.405-590 200.405-560	Cranked arm 5,5 mm; for MFW 250 Diamond tip 2 μ m / 90° (compatible with 6851816) Diamond tip 5 μ m / 90° (compatible with 6851834) Diamond tip 5 μ m / 60° (compatible with 6851836)	233,00 288,00 288,00
		
200.406-290 200.406-590	Cranked arm 14 mm; for MFW 250 Diamond tip 2 μ m / 90° Diamond tip 5 μ m / 90° (compatible with 6851824 / 9028254)	267,00 322,00
		
200.407-290 200.407-590	Cranked arm 20 mm; for MFW 250 Diamond tip 2 μ m / 90° Diamond tip 5 μ m / 90° (compatible with 6851830)	295,00 350,00
		
REP012	Réparation pickup Mahr MFW / FRW (therefore, please send us your tracing arm) Delivery time approx. 4 - 6 weeks	168,00

Dimensions in mm; all pictures diagrammatical

- According to your wishes we produce special pickup tracing arms, as well as tracing arms of other makers
- Prices for other quantities on request

Pickup Mahr FRW750

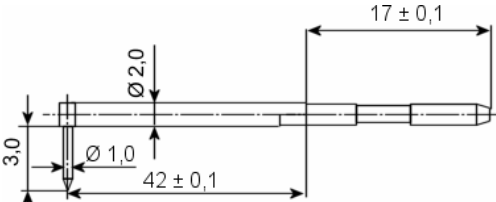
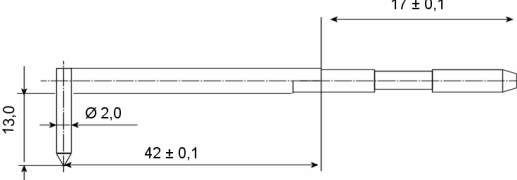
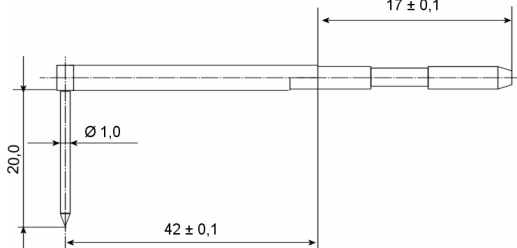
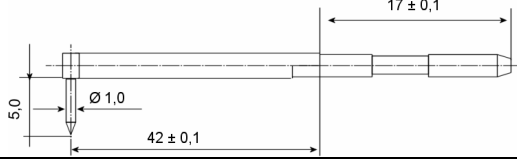
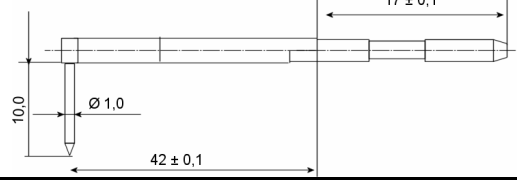
Order-no..	specification	Price in €
200.473-290	Cranked arm 3,0 mm for FRW-750 Diamond tip 2 μm / 90° (compatible with 6851406) 	235,00
200.471-1090	Cranked arm 13 mm; for FRW 750 Diamond tip 10 μm / 90° (compatible with 9014117) 	289,00
200.472-290	Cranked arm 20 mm; for FRW 750 Diamond tip 2 μm / 90° (compatible with 6851410) 	289,00
200.474-290	Cranked arm 5 mm; for FRW 750 Diamond tip 2 μm / 90° (compatible with 6851416) 	289,00
200.475-290	Cranked arm 10 mm; for FRW 750 Diamond tip 2 μm / 90° (compatible with 6851426) 	289,00
REP012	Réparation pickup Mahr MFW / FRW (therefore, please send us your tracing arm) delivery appr. 4-6 weeks	168,00

Pickup for roughness tester Hommel TKU 300/600

order-no.	Specification	Price in €
200.503-290	Pickup for bore greater than $\varnothing 4,0$ mm; for TKU 300 / 600 Diamond tip $2 \mu\text{m} / 90^\circ$ (compatible with 240805)	233,00
200.503-260	Diamond tip $2 \mu\text{m} / 60^\circ$ (compatible with 233218)	263,00
200.503-590	Diamond tip $5 \mu\text{m} / 90^\circ$ (compatible with 230475)	288,00
200.503-560	Diamond tip $5 \mu\text{m} / 60^\circ$	288,00
200.504-290	Cranked arm 11 mm; for TKU 300 / 600 Diamond tip $2 \mu\text{m} / 90^\circ$ (compatible with 256624)	237,00
200.504-260	Diamond tip $2 \mu\text{m} / 60^\circ$ (kompatibel with 240158)	267,00
200.504-590	Diamond tip $5 \mu\text{m} / 90^\circ$ (kompatibel with 231289)	292,00
200.502-290	Double length arm for bore greater than $\varnothing 4,0$ mm range $\pm 600 \mu\text{m}$; for TKU 300 / 600 Diamond tip $2 \mu\text{m} / 90^\circ$ (compatible with 240156)	247,00
200.502-260	Diamond tip $2 \mu\text{m} / 60^\circ$	277,00
200.502-590	Diamond tip $5 \mu\text{m} / 90^\circ$ (compatible with 230480)	302,00
200.510-290	Pickup for bore greater than $\varnothing 0,8$ mm; for TKU 300 / 600 Diamond tip $2 \mu\text{m} / 90^\circ$	340,00
200.510-260	Diamond tip $2 \mu\text{m} / 60^\circ$ (compatible with 233336)	370,00
200.510-590	Diamond tip $5 \mu\text{m} / 90^\circ$ (compatible with 233320)	395,00
200.510-560	Diamond tip $5 \mu\text{m} / 60^\circ$ (compatible with 233372)	395,00

Dimensions in mm; all pictures diagrammatical

- According to your wishes we produce special pickup tracing arms, as well as tracing arms of other makers
- Prices for other quantities on request

Pickup for roughness tester Zeiss

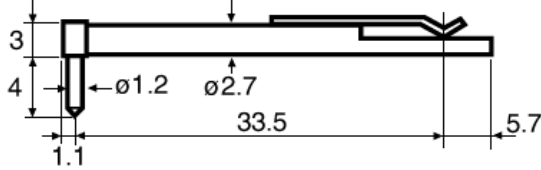
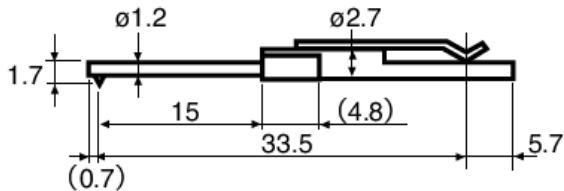
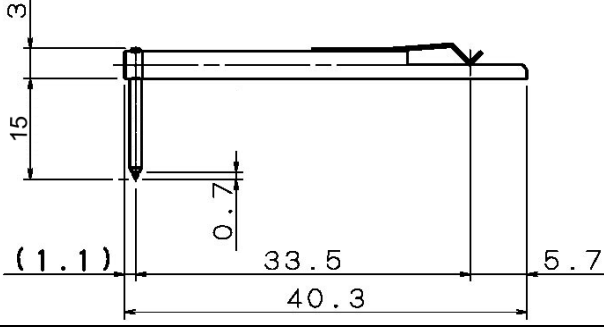
order-no.	Specification	Price in €
200.600-260 200.600-590	<p>Pickup for for bore greater than $\varnothing 7,5$ mm Diamond tip $2 \mu\text{m} / 60^\circ$ (compatible with DT43801) Diamond tip $5 \mu\text{m} / 90^\circ$ (compatible with 0102501)</p> 	<p>235,00 188,00</p>
200.630-260 200.630-590	<p>Pickup for for bore greater than $\varnothing 2$ mm Diamond tip $2 \mu\text{m} / 60^\circ$ (compatible with DT43812) Diamond tip $5 \mu\text{m} / 90^\circ$ (compatibel with 0102512)</p> 	<p>209,00 188,00</p>
200.610-260 200.610-590	<p>Pickup cranked 15 mm Diamond tip $2 \mu\text{m} / 60^\circ$ (compatible with DT43815) Diamond tip $5 \mu\text{m} / 90^\circ$ (compatible with 0102515)</p> 	<p>187,00 188,00</p>

Dimensions in mm; all pictures diagrammatical

- According to your wishes we produce special pickup tracing arms, as well as tracing arms of other makers
- Prices for other quantities on request

Pickup for roughness tester Mitutoyo

Order-no.	specification	Price in €
200.805-290 200.805-590	Pickup standard for bore greater than \varnothing 8 mm Diamond tip 2 μ m / 90° (compatible with 12AAC731) Diamond tip 5 μ m / 90° (compatible with 12AAB403)	235,00 242,00
200.806-290 200.806-590	Pickup for grooves 10 mm Diamond tip 2 μ m / 90° (compatible with 12AAC735) Diamond tip 5 μ m / 90° (compatible with 12AAB409)	252,00 259,00
200.802-290 200.802-590	Double length arm for deep bore greater than \varnothing 8 mm Diamond tip 2 μ m / 90° (compatible ave 12AAC740) Diamond tip 5 μ m / 90° (compatible with 12AAB413)	282,00 289,00
200.810-290 200.810-590	Pickup for small bore greater than \varnothing 1,0 mm Diamond tip 2 μ m / 90° (compatible with 12AAC734) Diamond tip 5 μ m / 90° (compatible with 12AAB406)	289,00 296,00

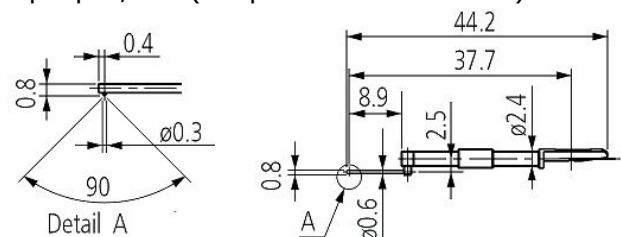
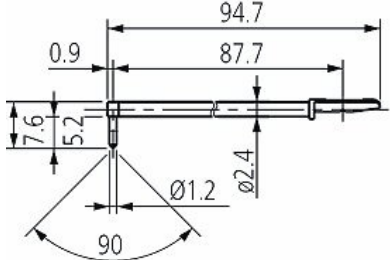
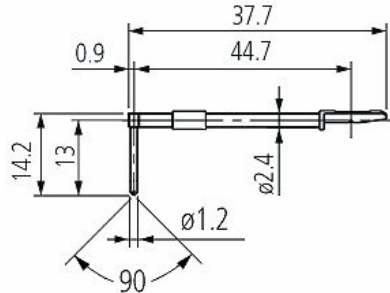
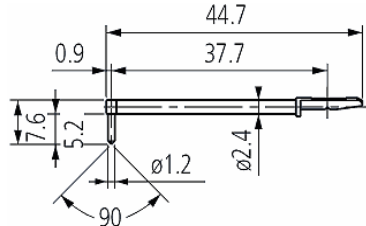

Dimensions in mm; all pictures diagrammatical

- According to your wishes we produce special pickup tracing arms, as well as tracing arms of other makers
- Prices for other quantities on request

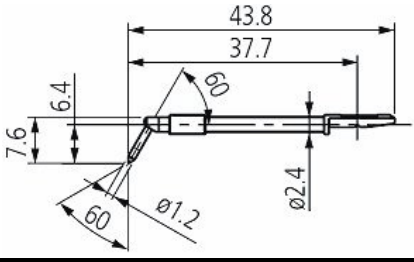
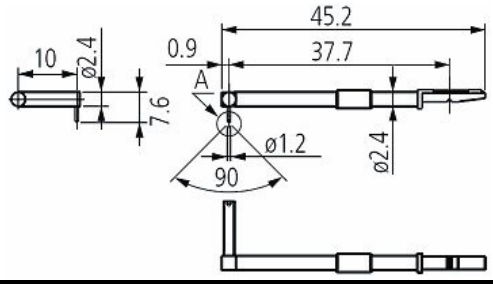
order-no.	Specification	Price in €
200.812-290	Pickup with inclined tip for bore greater than Ø 8,0 mm	282,00
200.812-590	Diamond tip 2 µm / 90° (compatible with 12AAB339) Diamond tip 5 µm / 90° (compatible with 12AAB410)	289,00
		
200.819-290	eccentric pickup for bore greater than Ø 8 mm	332,00
200.819-590	Diamond tip 2 µm / 90° (compatible with 12AAC739) Diamond tip 5 µm / 90° (compatibel with 12AAB412)	340,00
		

Dimensions in mm; all pictures diagrammatical

- According to your wishes we produce special pickup tracing arms, as well as tracing arms of other makers
- Prices for other quantities on request